

Article number: 54810052071

Description: 4 hole Flange Unit SSUCF207 for shaft $\varnothing 35\text{mm}$
Massive stainless steel, mat

Measures

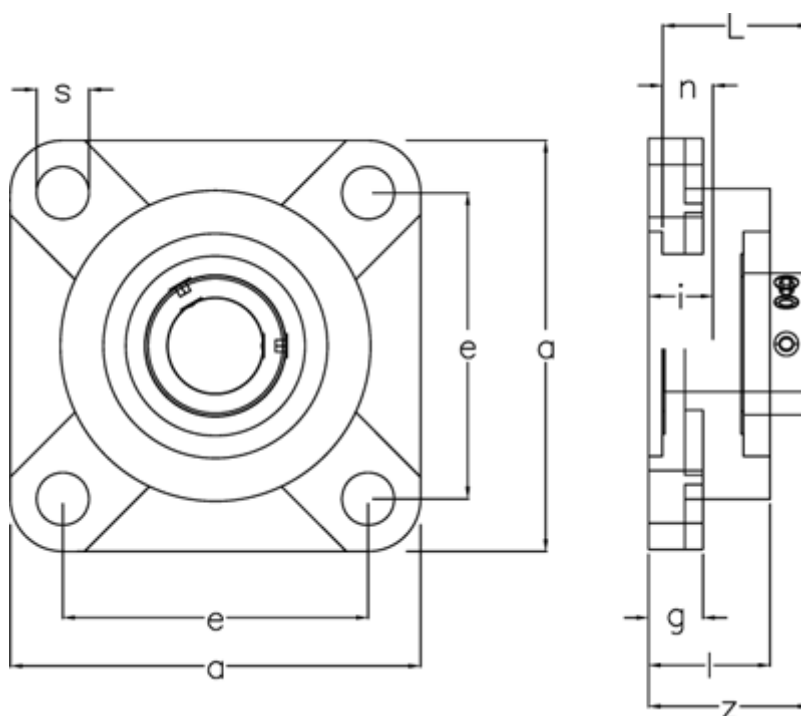

a	= 117	L	= 42.9
Bearing	= SUC207	Nominal drive	= 17.5
Bolt size	= M14	s	= 13
e	= 92	Weight	= 1.61
g	= 15.5	z	= 44.4
Housing	= SF207		
i	= 19		
l	= 34.0		